

KLT-M3MA-AR1335 V2.0 PLCC NIR

13MP OnSemi AR1335 PLCC MIPI Interface No IR Lens Auto Focus Camera Module



Front View



Back View

Specifications

| | |
|--------------------------|-------------------------------------|
| Camera Module No. | KLT-M3MA-AR1335 V2.0 PLCC NIR |
| Resolution | 13MP |
| Image Sensor | AR1335 PLCC |
| Sensor Type | 1/3.2" |
| Pixel Size | 1.1 um x 1.1 um |
| EFL | 3.81 mm |
| F.NO | 2.20 |
| Pixel | 4208 x 3120 |
| View Angle | 74.4°(DFOV) 62.7°(HFOV) 48.7°(VFOV) |
| Lens Dimensions | 8.50 x 8.50 x 5.60 mm |
| Module Size | 110.00 x 8.50 mm |
| Module Type | Auto Focus |
| Interface | MIPI |
| Auto Focus VCM Driver IC | CN3927 |
| Lens Model | KLT-LENS-50013A1 |
| Lens Type | No IR Filter Lens |
| Operating Temperature | -30°C to +70°C |
| Mating Connector | DF30FC-30DS-0.4V |



KLT-M3MA-AR1335 V2.0 PLCC NIR

13MP OnSemi AR1335 PLCC MIPI Interface No IR Lens Auto Focus Camera Module



Top View

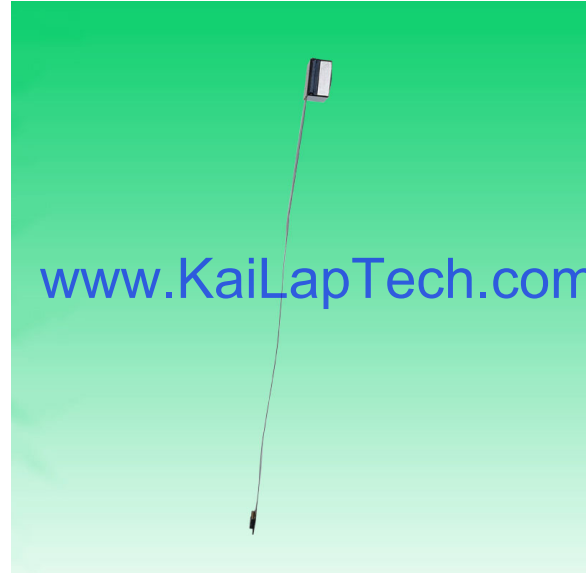

Side View



Bottom View



Mating Connector

ROHS

| PIN | SIGNAL |
|-----|-------------|
| 1 | AFVDD 2.8V |
| 2 | NC |
| 3 | DVDD 1.2V |
| 4 | DOV/DD 1.8V |
| 5 | NC |
| 6 | AGND |
| 7 | AVDD 2.8V |
| 8 | DGND |
| 9 | SDA |
| 10 | SCL |
| 11 | RESET |
| 12 | NC |
| 13 | GND |
| 14 | MCLK |
| 15 | GND |
| 16 | MDP3 |
| 17 | MDN3 |
| 18 | GND |
| 19 | MDP2 |
| 20 | MDN2 |
| 21 | GND |
| 22 | MDP1 |
| 23 | MDN1 |
| 24 | GND |
| 25 | MCP |
| 26 | MCN |
| 27 | GND |
| 28 | MDP0 |
| 29 | MDN0 |
| 30 | GND |

| Version | Information | Date |
|---------|---------------------------------|------------|
| V1.0 | First Version | 10-18-2019 |
| V2.0 | Change PIN signal and connector | 3-9-2021 |

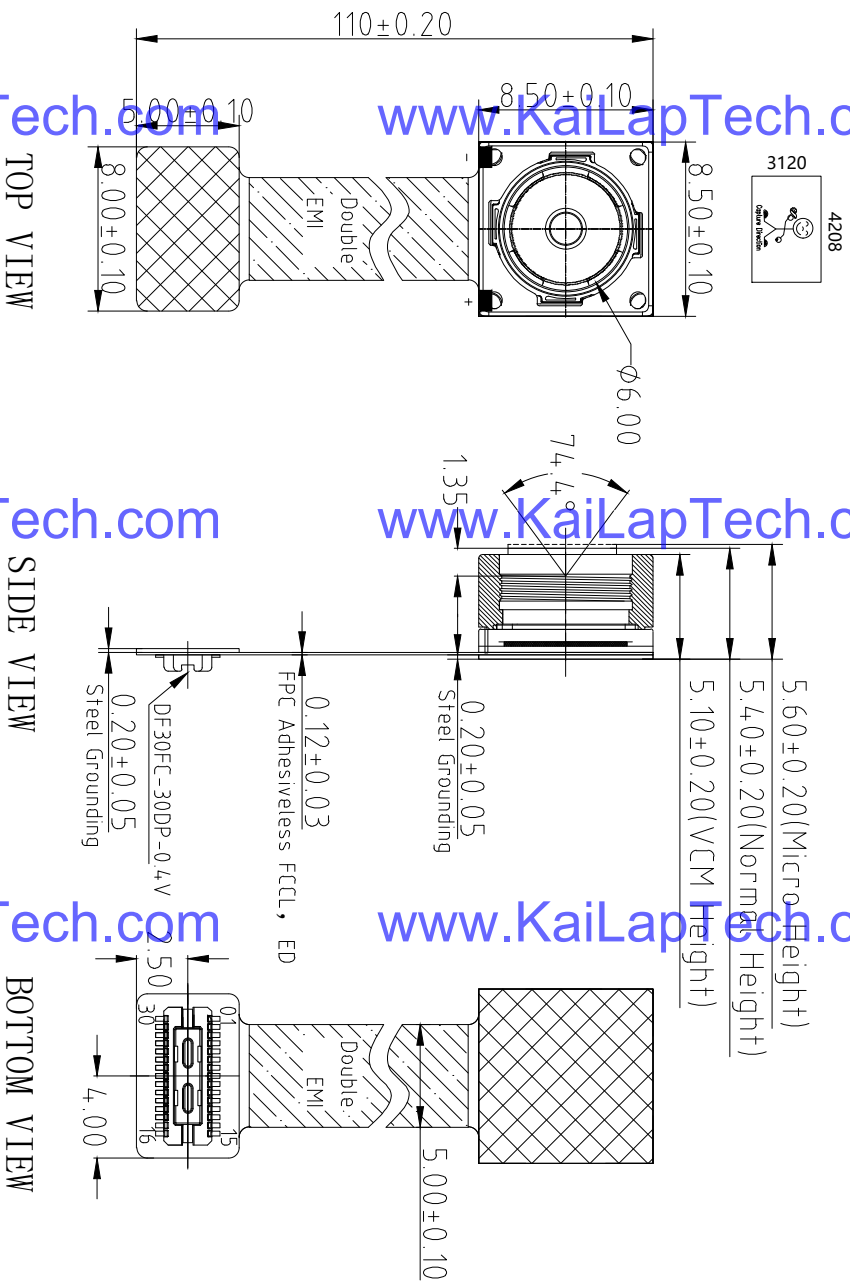

NOTE:
1. The device slave address: 0x6C(w), 0x6D(r)

Parameter:

1. **Sensor specification:**
Image Sensor: AR1335C32SMD20
Pixel: $1.1\mu\text{m} \times 1.1\mu\text{m}$
Lens Type: 1/3.2
Important Voltage Description: DVDD1.2V (external power supply);

2. Lens specification:

FOV: $74.4^\circ(D), 62.7^\circ(H), 48.7^\circ(V)$
F/No: 2.2
TV Distortion: $< 1.5\%$
Focal length: 3.81mm
Composition: 5P

Kai Lap Technologies Group Ltd

Designed By

Kevin

Model Name:

KLT-M3MA-AR1335 V2.0 PLCC NIR

Checked By

Aouly_Yan

Projection Type:

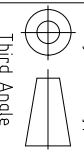

Unit: mm

Material: -----

Scale:

1:1

Sheet:

1 of 1

Version:

1/0

Lens Model: KLT-LENS-50013A1

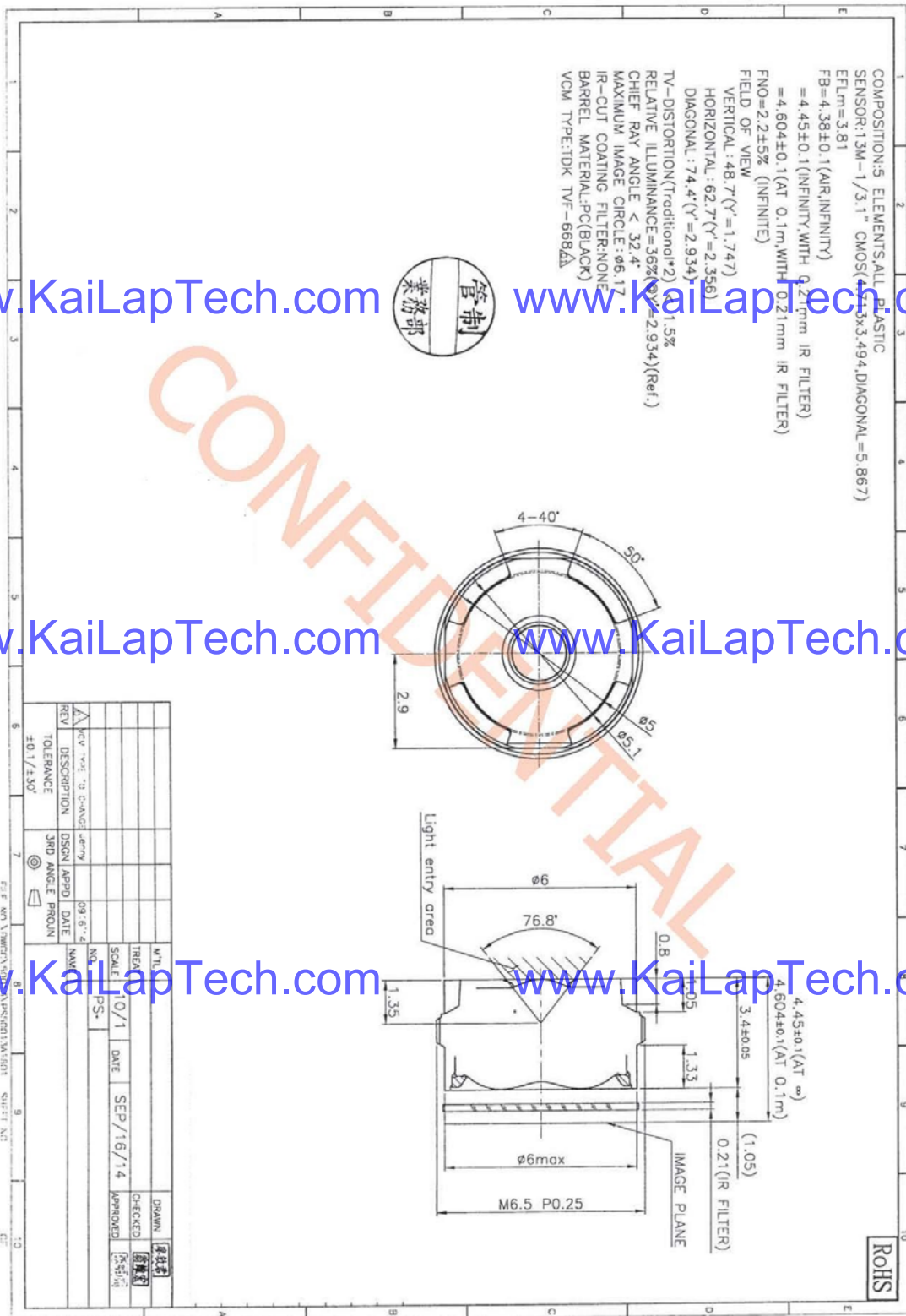

CN3927

Low Voltage Voice Coil Motor Driver with I2C interface

1. Description

The CN3927 is single 10-bit DAC with 150mA output current sink capability. Designed for linear control of voice coil motors, the CN3927 is capable of operating voltage from 2.3V to 5.5V. The DAC is controlled via a I2C serial interface that operates DAC by clock rates up to 400kHz.

The CN3927 incorporates with a UVLO reset circuit, power-down function, and exactly matched sense resistor. UVLO reset circuit ensure when supply power up, DAC output is to 0V until valid write-bit value takes place. It has a power down features that reduces the current consumption of the device to 1uA maximum.

The CN3927 is designed for auto focus and optical zoom camera phones, digital still cameras, and camcorders applications. The I2C address for the CN3927 is 0x18.

Features

- WLCSP package for minimum footprint
- Ramp control circuit
- Fixed I²C logic thresholds
- 10-bit D-to-A converter
- 146μA *I_{out}* resolution
- I2C serial interface (1.8V input available)
- Low current sleep mode
- 2.3 to 5.5 V power supply

Applications

- Digital camera
- Cell phone
- Lens auto focus
- Web camera

Package:

- 6-Bump Chip Scale Package
- 0.80mm (W) x 1.20mm (H) x 0.3mm (T)
- 0.4mm Bump Pitch



2. Functional Block Diagram

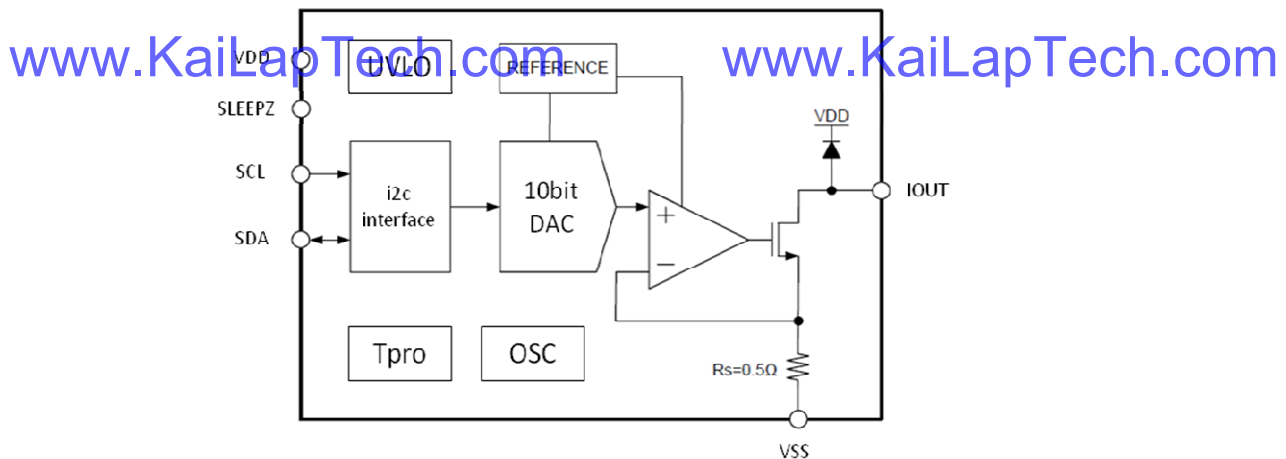

0.4 mm Pitch, 0.9 mm Height, Board-to-Board / Board-to-FPC Connectors

DF30 Series

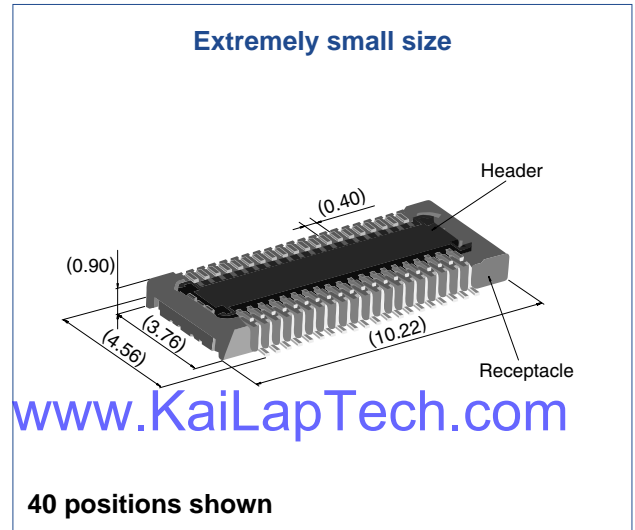
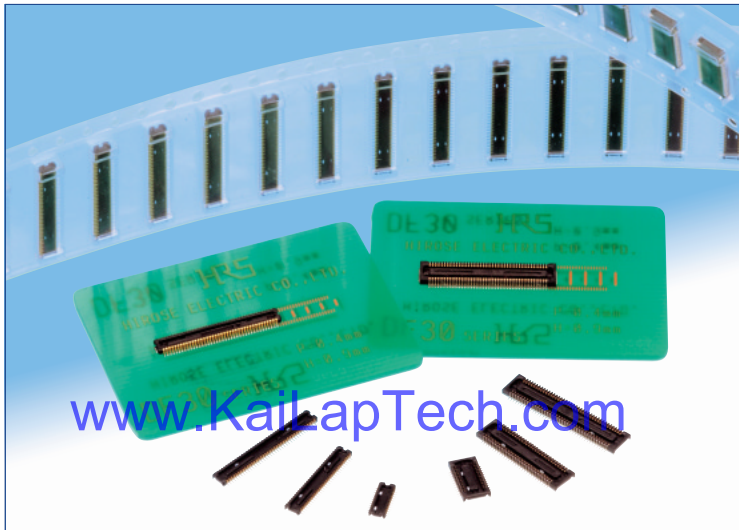

Overview

Continuous miniaturization and increased component density on PCB created demand for extremely low profile connectors. This series is addition of a new extremely low profile connectors to Hirose's wide range of high reliability board-to-board/board-to-FPC connection solutions.

Features

- 1. Contact reliability**
Concentration of the contact's normal forces at the single point assures good contact wipe and electrical reliability, while confirming the fully mated condition with a definite tactile click.
- 2. Self alignment**
Recognizing the difficulties of mating extremely small connectors in limited spaces the connectors will self align in horizontal axis within 0.3 mm.
- 3. Automatic board placement**
Packaged on tape-and-reel the plug and headers have sufficiently large flat areas to allow pick-up with vacuum nozzles of automatic placement equipment.
- 4. Variety of contact positions and styles**
Available in standard contact positions of: 20, 22, 24, 30, 34, 40, 50, 60, 70 and 80 with and without metal fittings. Addition of metal fittings does not affect external dimensions of the connectors. Smaller contact positions are also available.
- 5. Support for continuity test connector**
Connectors which have increased insertion and removal durability are available for continuity tests. Contact your Hirose sales representative for details.

Applications

Cellular phones, PDA's, mobile computers, digital cameras, digital video cameras, and other devices demanding high reliability connections in extremely limited spaces.

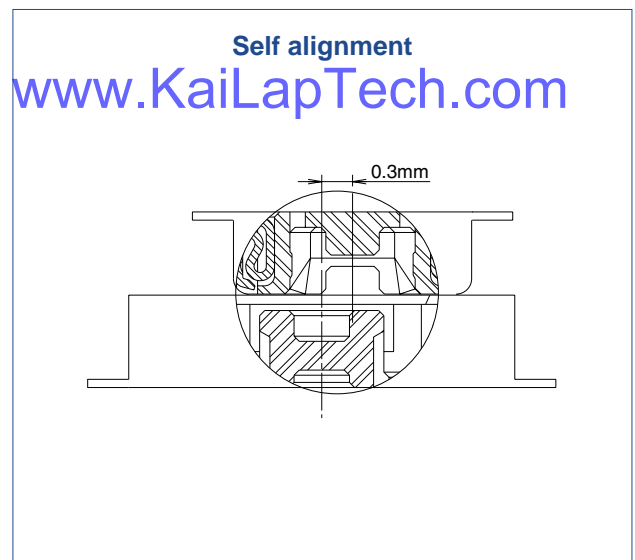
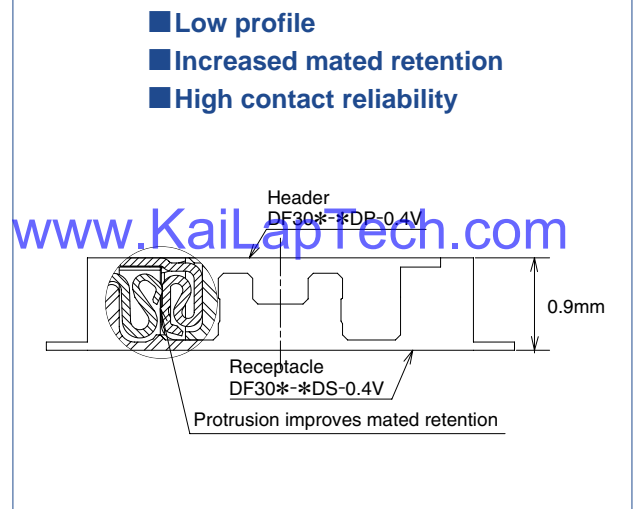

Product Specifications

| | | | |
|--------|--|---|--|
| Rating | Rated current 0.3A Rated voltage 30V AC | Operating temperature range : -35°C to 85°C (Note 1) Operating humidity range : Relative humidity 20% to 80% | Storage temperature range -10°C to 60°C (Note 2) Storage humidity range Relative humidity 40% to 70% (Note 2) |
|--------|--|---|--|

| Item | Specification | Conditions |
|--|--|--|
| 1. Insulation resistance | 50 MΩ min. | 100V DC |
| 2. Withstanding voltage | No flashover or insulation breakdown. | 100V AC / one minute |
| 3. Contact resistance | 100 mΩ max. | 100 mA |
| 4. Vibration | No electrical discontinuity of 1 μs or more | Frequency: 10 to 55 Hz, single amplitude of 0.75mm, 2 hours, 3 axis |
| 5. Humidity | Contact resistance: 100 mΩ max. Insulation resistance: 25 MΩ min. | 96 hours at temperature of 40°C±2°C and RH of 90% to 95% |
| 6. Temperature cycle | Contact resistance: 100 mΩ max. Insulation resistance: 50 MΩ min. | Temperature: -55°C→+5°C to +35°C→+85°C→+5°C to +35°C Duration: 30→10→30→10(Minutes) 5 cycles |
| 7. Durability (insertions/withdrawals) | Contact resistance: 100 mΩ max. | 50 cycles (Connector for conductivity tests: 500 cycles) |
| 8. Resistance to soldering heat | No deformation of components affecting performance. | Reflow: At the recommended temperature profile Manual soldering: 300°C for 3 seconds |

Note 1: Includes temperature rise caused by current flow.

Note 2: The term "storage" refers to products stored for long period of time prior to mounting and use. Operating temperature range and humidity range covers non-conducting condition of installed connectors in storage, shipment or during transportation.

Materials and Finishes

| Connectors | Component | Material | Finish | Remarks |
|-------------------------|----------------|-----------------|-------------------|---------|
| Receptacles and Headers | Insulator | LCP | Color : Black | UL94V-0 |
| | Contacts | Phosphor bronze | Gold plated | |
| | Metal fittings | Phosphor bronze | Tin-copper plated | |

Ordering information

Receptacles and Headers

DF30 FC - * DS - 0.4 V (**)

1 2 3 4 5 6 7

| | |
|--|---|
| ① Series name: DF30 | ⑤ Contact pitch: 0.4 mm |
| ② Configuration FB: With metal fittings, without bosses FC: Without metal fittings, without bosses CJ: Connector for conductivity tests | ⑥ Termination section V: Straight SMT |
| ③ Number of positions: 20, 22, 24, 30, 34, 40, 50, 60, 70, 80 | ⑦ Packaging (81): Embossed tape packaging (5,000 pieces per reel) (82): Embossed tape packaging (1,000 pieces per reel) |
| ④ Connector type DS: Double row receptacle DP: Double row header | |

■ Receptacles (without metal fittings)

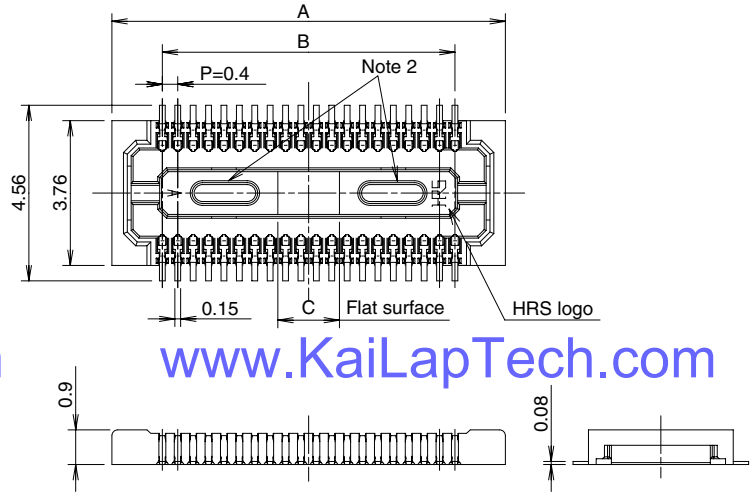
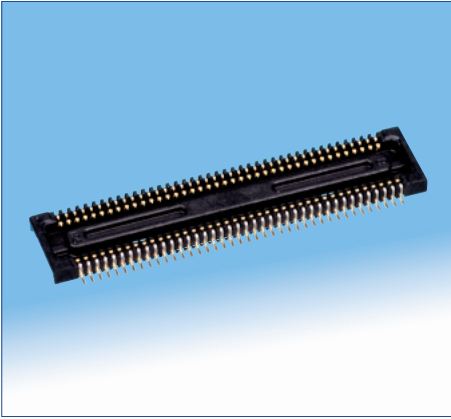

www.KaiLapTech.com

www.KaiLapTech.com

◆ Recommended PCB mounting pattern

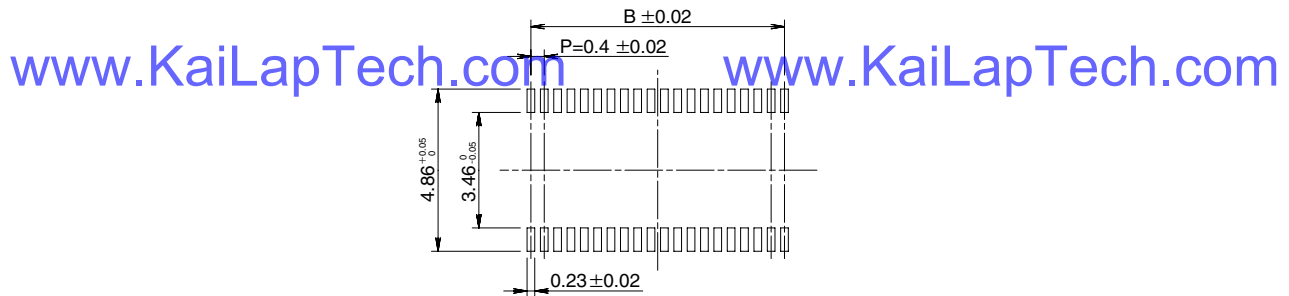

Recommended solder paste thickness: 120 μm

www.KaiLapTech.com [Specification number] -**, (**)
(81): Embossed tape packaging (5 000 pieces per reel) www.KaiLapTech.com

* Tolerances non- accumulative.

Unit: mm

| Part Number | CL No. | Number of contacts | A | B | C |
|----------------------|-----------------|--------------------|-------|------|------|
| DF30FC-20DS-0.4V(**) | CL684-1109-8-** | 20 | 6.22 | 3.6 | 1.2 |
| DF30FC-22DS-0.4V(**) | CL684-1110-7-** | 22 | 6.62 | 4.0 | 1.2 |
| DF30FC-24DS-0.4V(**) | CL684-1111-0-** | 24 | 7.02 | 4.4 | 1.2 |
| DF30FC-30DS-0.4V(**) | CL684-1112-2-** | 30 | 8.22 | 5.6 | 1.2 |
| DF30FC-34DS-0.4V(**) | CL684-1113-5-** | 34 | 9.02 | 6.4 | 1.36 |
| DF30FC-40DS-0.4V(**) | CL684-1078-6-** | 40 | 10.22 | 7.6 | 1.6 |
| DF30FC-50DS-0.4V(**) | CL684-1114-8-** | 50 | 12.22 | 9.6 | 2.0 |
| DF30FC-60DS-0.4V(**) | CL684-1082-3-** | 60 | 14.22 | 11.6 | 2.4 |
| DF30FC-70DS-0.4V(**) | CL684-1115-0-** | 70 | 16.22 | 13.6 | 2.8 |
| DF30FC-80DS-0.4V(**) | CL684-1116-3-** | 80 | 18.22 | 15.6 | 3.2 |

Note 1: Order by number of reels.

Note 2: Receptacles with 24 or fewer contacts positions will not have recessed areas.

Product Overview

AR1335: 13 MP 1/3" CMOS Image Sensor

For complete documentation, see the data sheet.

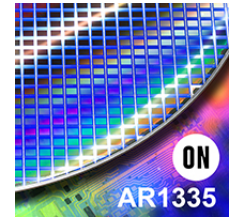

The AR1335 is a 1/3.2-inch CMOS active-pixel digital image sensor with a pixel array of 4208H x 3120V. The AR1335 digital image sensor, features breakthrough 1.1 μm pixel technology that delivers superior low-light image quality through leading sensitivity, quantum efficiency and linear full well. This allows image quality that rivals digital still cameras. With a sensor architecture focused on low power and a high Chief Ray Angle (CRA) for low Z-heights, the AR1335 is ideal for smartphone and other mobile device applications. It incorporates sophisticated on-chip camera functions such as windowing, mirroring, column and row skip modes, and snapshot mode. It is programmable through a simple two-wire serial interface. The AR1335 sensor can generate full resolution image at up to 30 frames per second (fps) and supports advanced video modes including 4K 30fps, 1080P 60fps and 720P 120fps.

Features

- 13MP CMOS sensor with advanced 1.1 μm pixel BSI technology
 - Data interfaces: 2, 3 and 4 lane MIPI
 - Bit-depth compression available for MIPI: 10-8 and 10-6 to lower bandwidth
 - 3D synchronization controls to enable stereo video capture
 - 6.8 kbits one time programmable memory (OTPM)
 - Programmable controls: gain, horizontal and vertical blanking, auto black level offset correction, frame size/rate, exposure, left-right and top-bottom image reversal, window size, and panning
 - Two on-die phase-locked loop (PLL) oscillators for super low noise performance
 - On-chip temperature sensor
 - Bayer pattern horizontal down-size scaler
 - Simple two-wire fast-mode+ serial interface
- For more features, see the data sheet

Applications

- Mobile
- 4K video capture
- High resolution still capture

End Products

- Smart Phone
- Digital Still Camera
- PC Camera
- Consumer devices

Part Electrical Specifications

| Product | Compliance | Status | Type | Megapixels | Frame Rate (fps) | Optical Format | Shutter Type | Pixel Size (μm) | Output Interface | Color | Package Type |
|----------------------|------------------------|--------|------|------------|------------------|----------------|--------------------|------------------------------|------------------|-------|--------------|
| AR1335CSSC11SMD20 | Pb-free Halide free | Active | CMOS | 13 | 30 | 1/3.2 inch | Electronic Rolling | 1.1 x 1.1 | MIPI | RGB | |
| AR1335CSSC11SMKA0-CP | Pb-free Halide free | Active | CMOS | 13 | 30 | 1/3.2 inch | Electronic Rolling | 1.1 x 1.1 | MIPI | RGB | ODCSP-63 |
| AR1335CSSC11SMKA0-CR | Pb-free Halide free | Active | CMOS | 13 | 30 | 1/3.2 inch | Electronic Rolling | 1.1 x 1.1 | MIPI | RGB | ODCSP-63 |
| AR1335CSSC32SMD20 | Pb-free Halide free | Active | CMOS | 13 | 30 | 1/3.2 inch | Electronic Rolling | 1.1 x 1.1 | MIPI | RGB | |
| AR1335CSSM11SMD20 | Pb-free Halide free | Active | CMOS | 13 | 30 | 1/3.2 inch | Electronic Rolling | 1.1 x 1.1 | MIPI | RGB | |
| AR1335CSSM32SMD20 | Pb-free Halide free | Active | CMOS | 13 | 30 | 1/3.2 inch | Electronic Rolling | 1.1 x 1.1 | MIPI | RGB | |



1/3.2-Inch 13 Mp CMOS Digital Image Sensor

AR1335 Datasheet, Rev. A

For the latest datasheet, please visit: www.aptna.com

Features

- 13 Mp CMOS sensor with advanced 1.1 μm pixel BSI technology
- Data interfaces: two-, three-, and four-lane serial mobile industry processor interface (MIPI)
- Bit-depth compression available for MIPI Interface: 10-8 and 10-6 to enable lower bandwidth receivers for full frame rate applications
- 3D synchronization controls to enable stereo video capture
- 6.8 kbits one-time programmable memory (OTPM) for storing shading correction coefficients and module information
- Programmable controls: gain, horizontal and vertical blanking, auto black level offset correction, frame size/rate, exposure, left-right and top-bottom image reversal, window size, and panning
- Two on-die phase-locked loop (PLL) oscillators for super low noise performance
- On-chip temperature sensor
- Bayer pattern horizontal down-size scaler
- Simple two-wire fast-mode+ serial interface
- Low dark current
- Interlaced multi-exposure readout enabling High Dynamic Range (HDR) still and video applications
- On-chip lens shading correction
- Support for external mechanical shutter
- Support for external LED or Xenon Flash
- Extended Flash duration up to start of frame readout

Applications

- Cellular phones
- Digital still cameras
- PC cameras
- PDAs

Table 1: Key Performance Parameters

| Parameter | Value | |
|--|---|------------------------------|
| Optical format | 1/3.2 inch 13 Mp (4:3) | |
| Active pixels | 4208H x 3120V | |
| Pixel size | 1.1 μm Back Side Illuminated (BSI) | |
| Chief ray angle (CRA) | 32° | |
| Die size | 6.3 mm x 5.7 mm | |
| Input clock frequency | 6 - 48 MHz | |
| Interface | 4-lane MIPI (2- and 3-lane supported); Max data rate: 1.2Gbps/lane | |
| Subsampling modes (column and row) | skip2 bin2 skip3 bin3 skip4 bin4 skip2bin2 | |
| ADC resolution | 10 bits, on-die | |
| Analog gain | 1x – 7.75x | |
| Digital gain | Up to 7.98x | |
| Scaler | Adjustable scaling up to 8x | |
| Temperature sensor | 10-bit, controlled by two-wire serial I/F | |
| Compression | DPCM: 10-8-10, 10-6-10 | |
| 3D support | Frame rate and exposure synchronization | |
| Supply voltage | VAA, VAA_PIX | 2.6 - 2.9 V (2.7 V nominal) |
| | VDD_IO, VDDIO_ANA | 1.7 - 1.9 V (1.8 V nominal) |
| | VDD, VDD_ANA, VDD_PLL, VDD_PHY | 1.14 - 1.3 V (1.2 V nominal) |
| Power consumption | 270 mW at 60°C (TYP) at 13 Mp 30 fps | |
| Responsivity | 4700 e ⁻ /lux-sec | |
| SNRMAX | 37 dB | |
| Dynamic Range | 69 dB | |
| Operating Temperature Range (at junction) - TJ | -30°C to +70°C | |



Table 2: Mode of Operation and Power

| Mode | Resolution | Readout Configuration | HFOV | FPS | Power Consumption [mW] |
|--------------------------------|-------------|--------------------------|------|-----|------------------------|
| 4:3 Snapshot Mode | | | | | |
| 13 M full resolution | 4208x3120 | 13M full mode | 100% | 30 | 270 |
| 13 M full resolution | 4208x3120 | 13M full mode | 100% | 24 | 250 |
| VGA | 640 x 480 | Crop+Subsampling+Scaling | 61% | 120 | 190 |
| QVGA | 320 x 240 | Crop+Subsampling+Scaling | 30% | 240 | 165 |
| 16:9 Video Mode 30 FPS | | | | | |
| 4K UHD | 3840 x 2160 | Cropping | 91% | 30 | 230 |
| 4K Cinema | 4096 x 2160 | Cropping | 97% | 30 | 235 |
| 1080p | 1920 x 1080 | Crop+Subsampling+Scaling | 91% | 30 | 160 |
| 1080p LP | 1920 x 1080 | Crop+Subsampling+Scaling | 91% | 30 | 135 |
| 720p | 1280 x 720 | Crop+Subsampling+Scaling | 91% | 30 | 140 |
| 16:9 Video Mode 60 FPS | | | | | |
| 1080p | 1920 x 1080 | Crop+Subsampling+Scaling | 91% | 60 | 210 |
| 1080p LP | 1920 x 1080 | Crop+Subsampling+Scaling | 91% | 60 | 180 |
| 720p | 1280 x 720 | Crop+Subsampling+Scaling | 91% | 60 | 175 |
| 3M 30 FPS | | | | | |
| 3M | 2000 x 1500 | Crop+Subsampling+Scaling | 95% | 30 | 195 |
| 3M LP | 2000 x 1500 | Crop+Subsampling+Scaling | 95% | 30 | 170 |
| 16:9 Video Mode 120 FPS | | | | | |
| 720p | 1280 x 720 | Crop+Subsampling+Scaling | 91% | 120 | 260 |

Ordering Information

Table 3: Available Part Numbers

| Part Number | Description |
|-------------------|-------------|
| AR1335C5SC32SMD20 | Bare die |



Camera Module Pinout Definition Reference Chart

| OmniVision | Sony | Samsung | On-Semi | Aptina | Himax | GalaxyCore | PixArt | SmartSens | Sensors |
|-------------------------------|------|---|---------|--------|-------|------------|--------|-----------|---------|
| Pin Signal | | Description | | | | | | | |
| DGND GND | | ground for digital circuit | | | | | | | |
| AGND | | ground for analog circuit | | | | | | | |
| PCLK DCK | | DVP PCLK output | | | | | | | |
| XCLR PWDN XSHUTDOWN STANDBY | | power down active high with internal pull-down resistor | | | | | | | |
| MCLK XVCLK XCLK INCK | | system input clock | | | | | | | |
| RESET RST | | reset active low with internal pull-up resistor | | | | | | | |
| NC NULL | | no connect | | | | | | | |
| SDA SIO_D SIOD | | SCCB data | | | | | | | |
| SCL SIO_C SIOC | | SCCB input clock | | | | | | | |
| VSYNC XVS FSYNC | | DVP VSYNC output | | | | | | | |
| HREF XHS | | DVP HREF output | | | | | | | |
| DOVDD | | power for I/O circuit | | | | | | | |
| AFVDD | | power for VCM circuit | | | | | | | |
| AVDD | | power for analog circuit | | | | | | | |
| DVDD | | power for digital circuit | | | | | | | |
| STROBE FSTROBE | | strobe output | | | | | | | |
| FSIN | | synchronize the VSYNC signal from the other sensor | | | | | | | |
| SID | | SCCB last bit ID input | | | | | | | |
| ILPWM | | mechanical shutter output indicator | | | | | | | |
| FREQ | | frame exposure / mechanical shutter | | | | | | | |
| GPIO | | general purpose inputs | | | | | | | |
| SLASEL | | I2C slave address select | | | | | | | |
| AFEN | | CEN chip enable active high on VCM driver IC | | | | | | | |
| MIPI Interface | | | | | | | | | |
| MDN0 DN0 MD0N DATA_N DMO1N | | MIPI 1st data lane negative output | | | | | | | |
| MDP0 DP0 MD0P DATA_P DMO1P | | MIPI 1st data lane positive output | | | | | | | |
| MDN1 DN1 MD1N DATA2_N DMO2N | | MIPI 2nd data lane negative output | | | | | | | |
| MDP1 DP1 MD1P DATA2_P DMO2P | | MIPI 2nd data lane positive output | | | | | | | |
| MDN2 DN2 MD2N DATA3_N DMO3N | | MIPI 3rd data lane negative output | | | | | | | |
| MDP2 DP2 MD2P DATA3_P DMO3P | | MIPI 3rd data lane positive output | | | | | | | |
| MDN3 DN3 MD3N DATA4_N DMO4N | | MIPI 4th data lane negative output | | | | | | | |
| MDP3 DP3 MD3P DATA4_P DMO4P | | MIPI 4th data lane positive output | | | | | | | |
| MCN CLKN CLK_N DCKN | | MIPI clock negative output | | | | | | | |
| MCP CLKP MCP CLK_P DCKN | | MIPI clock positive output | | | | | | | |
| DVP Parallel Interface | | | | | | | | | |
| D0 DO0 Y0 | | DVP data output port 0 | | | | | | | |
| D1 DO1 Y1 | | DVP data output port 1 | | | | | | | |
| D2 DO2 Y2 | | DVP data output port 2 | | | | | | | |
| D3 DO3 Y3 | | DVP data output port 3 | | | | | | | |
| D4 DO4 Y4 | | DVP data output port 4 | | | | | | | |
| D5 DO5 Y5 | | DVP data output port 5 | | | | | | | |
| D6 DO6 Y6 | | DVP data output port 6 | | | | | | | |
| D7 DO7 Y7 | | DVP data output port 7 | | | | | | | |
| D8 DO8 Y8 | | DVP data output port 8 | | | | | | | |
| D9 DO9 Y9 | | DVP data output port 9 | | | | | | | |
| D10 DO10 Y10 | | DVP data output port 10 | | | | | | | |
| D11 DO11 Y11 | | DVP data output port 11 | | | | | | | |



your BEST camera module partner

Cameras Applications



www.KaiLapTech.com



www.KaiLapTech.com



www.KaiLapTech.com

www.KaiLapTech.com



www.KaiLapTech.com



www.KaiLapTech.com



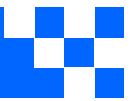

Camera Reliability Test

| Reliability Inspection Item | | Testing Method | Acceptance Criteria | |
|-----------------------------|--|---|-------------------------|-------------------------|
| Category | Item | | | |
| Environmental | Storage Temperature | High 60°C 96 Hours | Temperature Chamber | No Abnormal Situation |
| | | Low -20°C 96 Hours | Temperature Chamber | No Abnormal Situation |
| | Operation Temperature | High 60°C 24 Hours | Temperature Chamber | No Abnormal Situation |
| | | Low -20°C 24 Hours | Temperature Chamber | No Abnormal Situation |
| | Humidity | 60°C 80% 24 Hours | Temperature Chamber | No Abnormal Situation |
| | Thermal Shock | High 60°C 0.5 Hours Low -20°C 0.5 Hours Cycling in 24 Hours | Temperature Chamber | No Abnormal Situation |
| Physical | Drop Test (Free Falling) | Without Package 60cm | 10 Times on Wood Floor | Electrically Functional |
| | | With Package 60cm | 10 Times on Wood Floor | Electrically Functional |
| | Vibration Test | 50Hz X-Axis 2mm 30min | Vibration Table | Electrically Functional |
| | | 50Hz Y-Axis 2mm 30min | Vibration Table | Electrically Functional |
| | | 50Hz Z-Axis 2mm 30min | Vibration Table | Electrically Functional |
| Cable Tensile Strength Test | Loading Weight 4 kg 60 Seconds Cycling in 24 Hours | Tensile Testing Machine | Electrically Functional | |
| Electrical | ESD Test | Contact Discharge 2 KV | ESD Testing Machine | Electrically Functional |
| | | Air Discharge 4 KV | ESD Testing Machine | Electrically Functional |
| | Aging Test | On/Off 30 Seconds Cycling in 24 Hours | Power Switch | Electrically Functional |
| | USB Connector | On/Off 250 Times | Plug and Unplug | Electrically Functional |





| Inspection Item | | Inspection Method | Standard of Inspection | |
|------------------|----------|-------------------|-----------------------------|--|
| Category | Item | | | |
| Appearance | FPC/ PCB | Color | The Naked Eye | Major Difference is Not Allowed. |
| | | Be Torn/Chopped | The Naked Eye | Copper Crack Exposure is Not Allowed. |
| | | Marking | The Naked Eye | Clear, Recognizable (Within 30cm Distance) |
| | Holder | Scratches | The Naked Eye | The Inside Crack Exposure is Not Allowed |
| | | Gap | The Naked Eye | Meet the Height Standard |
| | | Screw | The Naked Eye | Make Sure Screws Are Presented (If Any) |
| | | Damage | The Naked Eye | The Inside Crack Exposure is Not Allowed |
| | Lens | Scratch | The Naked Eye | No Effect On Resolution Standard |
| | | Contamination | The Naked Eye | No Effect On Resolution Standard |
| | | Oil Film | The Naked Eye | No Effect On Resolution Standard |
| | | Cover Tape | The Naked Eye | No Issue On Appearance. |
| | Function | Image | No Communication | Test Board |
| Bright Pixel | | | Black Board | Not Allowed In the Image Center |
| Dark Pixel | | | White board | Not Allowed In the Image Center |
| Blurry | | | The Naked Eye | Not Allowed |
| No Image | | | The Naked Eye | Not Allowed |
| Vertical Line | | | The Naked Eye | Not Allowed |
| Horizontal Line | | | The Naked Eye | Not Allowed |
| Light Leakage | | | The Naked Eye | Not Allowed |
| Blinking Image | | | The Naked Eye | Not Allowed |
| Bruise | | | Inspection Jig | Not Allowed |
| Resolution | | | Chart | Follows Outgoing Inspection Chart Standard |
| Color | | | The Naked Eye | No Issue |
| Noise | | | The Naked Eye | Not Allowed |
| Corner Dark | | | The Naked Eye | Less Than 100px By 100px |
| Color Resolution | | | The Naked Eye | No Issue |
| Dimension | Height | The Naked Eye | Follows Approval Data Sheet | |
| | Width | The Naked Eye | Follows Approval Data Sheet | |
| | Length | The Naked Eye | Follows Approval Data Sheet | |
| | Overall | The Naked Eye | Follows Approval Data Sheet | |



KLT Package Solutions

KLT Camera Module



Complete with Lens Protection Film



Tray with Grid and Space



Place Cameras on the Tray



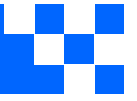

Camera Modules Package Solution

Full Tray of Cameras



Cover Tray with Lid



Put Tray into Anti-Static Bag



Vacuum the Anti-Static Bag

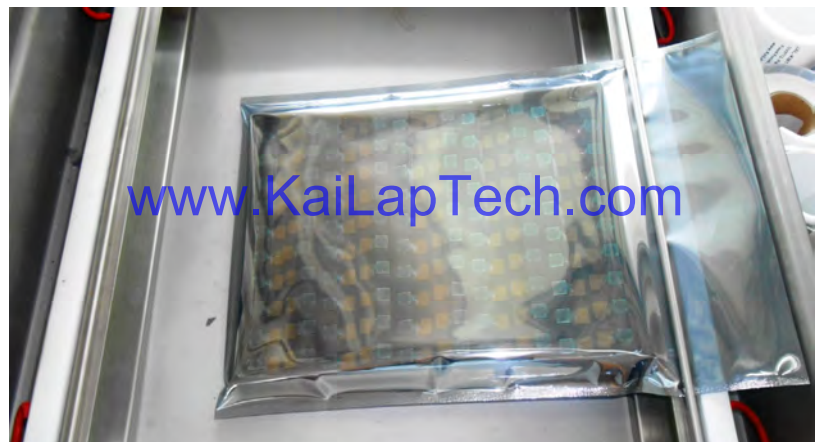



Camera Modules Package Solution

Sealed Vacuum Bag with Labels

- 1. Model and Description 2. Quantity 3. Shipping Date 4. Caution**





CMOS CAMERA MODULES



your BEST camera module partner

Large Order Package Solution

Place Foam Sheets Between Trays

Foam Sheets are Slightly Larger than Trays



www.KaiLapTech.com

www.KaiLapTech.com

Place Foam Sheets and Trays into Box

Foam Sheets are Tightly Fitting Box



www.KaiLapTech.com sales@KaiLapTech.com Tel: (852) 6908 1256 Fax: (852) 3017 6778

All rights reserved @ Kai Lap Technologies Group Ltd. Specifications subject to change without notice.



CMOS CAMERA MODULES



your BEST camera module partner

Small Order Package Solution

Place Foam Sheets and Trays into Small Box

Foam Sheets are Nicely Fitting the Small Box



www.KaiLapTech.com

www.KaiLapTech.com

Package in Small Box for Shipment

Place Small Boxes into Larger Box



www.KaiLapTech.com

www.KaiLapTech.com

www.KaiLapTech.com sales@KaiLapTech.com Tel: (852) 6908 1256 Fax: (852) 3017 6778

All rights reserved @ Kai Lap Technologies Group Ltd. Specifications subject to change without notice.



Carbon Box Package Solution

Seal the Carbon Box

Final Package Labelled Box



Carbon Box Ready for Shipment

1. Delivery Address and Phone No.
2. Box No. and Ship Date
3. Fragile Caution





Sample Order Package Solution

Place Sample into Small Anti-Static Bag



Place Connectors into Small Ant-Static Bag



Sample Labels on the Small Bag

1. Camera Module or Connector Model
2. Shipping Date and Quantity
3. Caution





Connectors Large Order Package Solution

Connectors in a Wheel



Label Connectors in the Wheel



The Wheel is Perfectly Fitting the Box



Connectors Box Ready for Shipment



Company Kai Lap Technologies (KLT)

Kai Lap Technologies Group Limited. (KLT) was established in 2009, a next-generation technology driven manufacturer specialized in research, design, and produce of audio and video products. KLT is occupying 20,000 square feet automated plants with 100 employees of annual throughput 30,000,000 units cameras.

KLT provides OEM, ODM design, contract manufacturing, and builds the camera products. You may provide the requirements to us, even with a hand draft, our sales and engineering work together to meet your needs. We consider ourselves your last-term partner in developing practical and innovative solutions.

Our team covers everything from initial concept development to mass produced product. KLT specializes in customized camera design, raw material, electronic engineering, firmware/software development, product testing, and packing design. Our experienced strategic supply systems offer a robust and dependable manufacturing capacity for orders of various sizes.

www.KaiLapTech.com

www.KaiLapTech.com



Limited Warranty

KLT provides the following limited warranty if you purchased the Product(s) directly from KLT company or from KLT's website, www.KaiLapTech.com. Product(s) purchased from other sellers or sources are not covered by this Limited Warranty. KLT guarantees that the Product(s) will be free from defects in materials and workmanship under normal use for a period of one (1) year from the date you receive the product ("Warranty Period").

For all Product(s) that contain or develop material defects in materials or workmanship during the Warranty Period, KLT will, at its sole option, either: (i) repair the Product(s); (ii) replace the Product(s) with a new or refurbished Product(s) (replacement Product(s) being of identical model or functional equivalent); or (iii) provide you a refund of the price you paid for the Product(s).

This Limited Warranty of KLT is solely limited to repair and/or replacement on the terms set forth above. KLT is not reliable or responsible for any subsequent events.





CMOS CAMERA MODULES



your BEST camera module partner

KLT Strength

Powerful Factory



www.KaiLapTech.com

www.KaiLapTech.com

Professional Service



www.KaiLapTech.com

www.KaiLapTech.com

Promised Delivery



www.KaiLapTech.com

www.KaiLapTech.com



www.KaiLapTech.com sales@KaiLapTech.com Tel: (852) 6908 1256 Fax: (852) 3017 6778

All rights reserved @ Kai Lap Technologies Group Ltd. Specifications subject to change without notice.